

[more]



BLOW BANK / BENCH DESIGN: BERNHARD MÜLLER, 2012

Bank mit Gurtpolsterung, Bezug aus Leder oder Stoff.
Optional mit verschiedenen Armlehnen erhältlich. Wahlweise Kufen aus poliertem Edelstahl oder anthrazitfarben pulverbeschichtete Stahlkufen. Ebenfalls wandhängend oder als Eckbank erhältlich, Sitztiefe: 55 cm, Sitzhöhe: 46,5 cm. Sonderhöhen nicht möglich.

Upholstered bench with elastic belting, with leather or fabric cover. Optionally available with different armrests. Choice of polished stainless steel runners or anthracite powder-coated steel runners. Also available wall-mounted or as a corner bench. Seat depth: 55 cm, seat height: 46,5 cm. Custom heights not available.

BLOW Bank ohne Rückenlehne, mit Kufen

BLOW bench without backrest, with runners

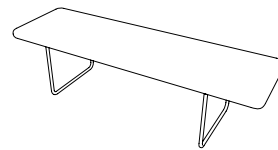
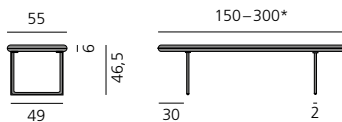

BLOW Eckbank

BLOW corner bench

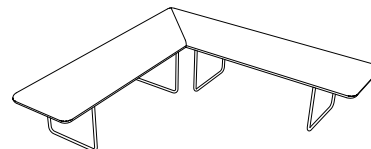
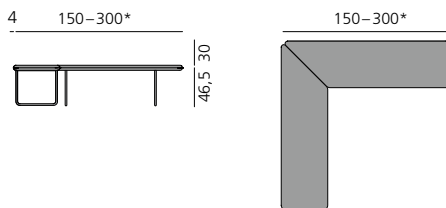

BLOW Bank, wandhängend

BLOW bench, wall-mounted

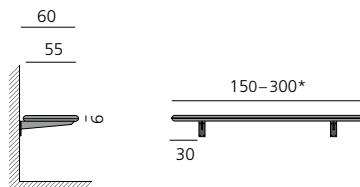

Wandaufhängung

Wall bracket

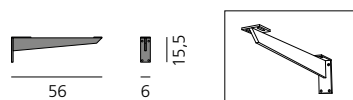

***Ab 220 cm mit dritter Kufe / Wandaufhängung!**
***From 220 cm with a third runner / wall attachment!**

BLOW mit Rückenlehne auf den nächsten Seiten >

BLOW with backrest on the following pages >

[more] Bernhard Müller GmbH

Bahrenfelder Steindamm 67A, 22761 Hamburg · Tel: 0049 (0)40-66 06 22 · info@more-moebel.de · www.more-moebel.de

[more]

BLOW Bank mit Rückenlehne 30 cm, ohne Armlehne

BLOW bench with backrest 30 cm, without armrest

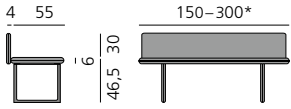

BLOW Bank mit Rückenlehne 30 cm, Armlehne einseitig

BLOW bench with backrest 30 cm, armrest one-sided

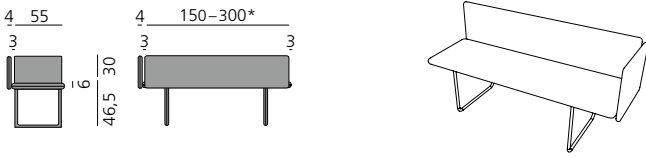

Armlehne beidseitig

armrest two-sided

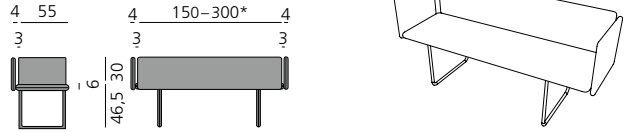

BLOW Eckbank mit Rückenlehne 30 cm, ohne Armlehne

BLOW Corner bench with backrest 30 cm, without armrest



BLOW Bank, wandhängend mit Rückenlehne 30 cm, Armlehne beidseitig

BLOW bench, wall-mounted with backrest 30 cm, armrest two-sided



Wandaufhängung

Wall bracket

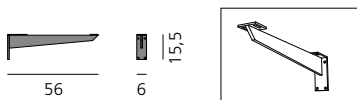

***Ab 220 cm mit dritter Kufe / Wandaufhängung!**
*From 220 cm with a third runner / wall attachment!

[more]

BLOW Bank mit Rückenlehne 50 cm, ohne Armlehne

BLOW bench with backrest 50 cm, without armrest

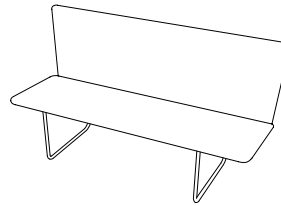
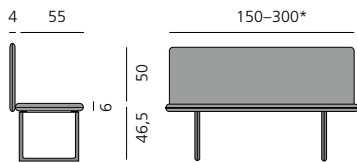

BLOW Bank mit Rückenlehne 50 cm, Armlehne einseitig

BLOW bench with backrest 50 cm, armrest one-sided

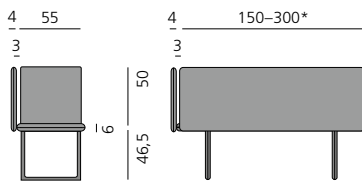

Armlehne beidseitig

armrest two-sided

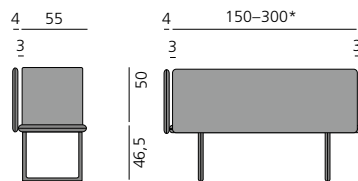

BLOW Eckbank mit Rückenlehne 50 cm, ohne Armlehne

BLOW Corner bench with backrest 50 cm, without armrest

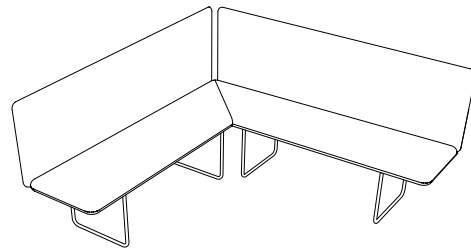
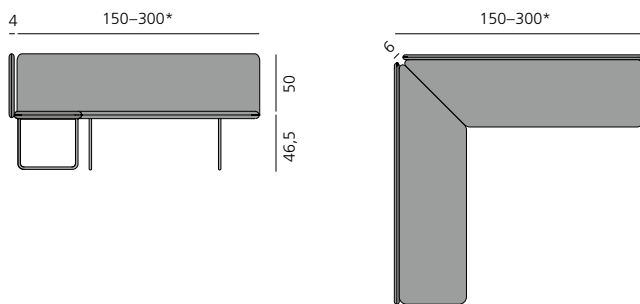

BLOW Bank, wandhängend mit Rückenlehne 50 cm, Armlehne beidseitig

BLOW bench, wall-mounted with backrest 50 cm, armrest two-sided

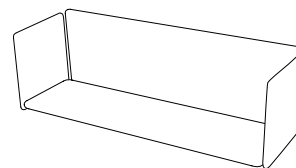
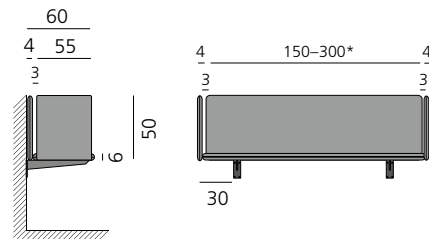

Wandaufhängung

Wall bracket

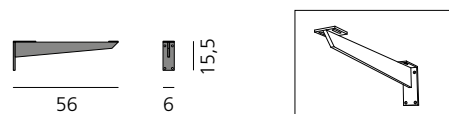

***Ab 220 cm mit dritter Kufe / Wandaufhängung!**

*From 220 cm with a third runner / wall attachment!