



# CALA Tisch / Table

Design: Gil Coste, 2018

Brettverleimte, durchlaufende Massivholzplatte.  
 Plattenstärke: 2,8 cm. Oberfläche geölt und gewachst  
 oder matt lackiert, siehe Holzmuster. Andere Hölzer,  
 Größen, Breiten und Farbtöne auf Anfrage. Untergestell  
 aus Massivholz. Tischhöhe: 74,5 cm.

Glued and laminated continuous solid wood tabletop,  
 Top thickness: 2,8 cm. Surface oiled and waxed or matt  
 varnished, see wood samples. Other wood types, sizes,  
 widths and color shades on request. Base made of solid  
 wood. Table height: 74,5 cm.

## CALA Barrel shape, Maserung längslaufend

CALA barrel shape, grain lengthwise

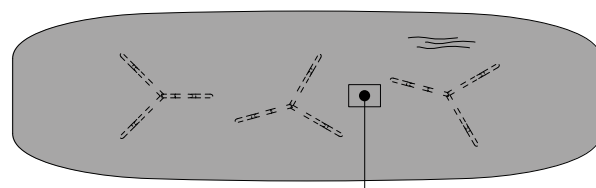
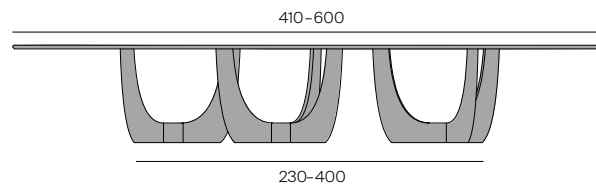
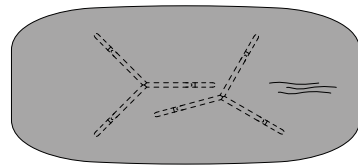
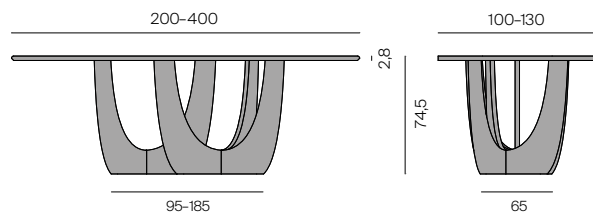

Kabelklappe (optional)  
 Cable flap (optional)

## Positionen der Gestelle

Positions of bases

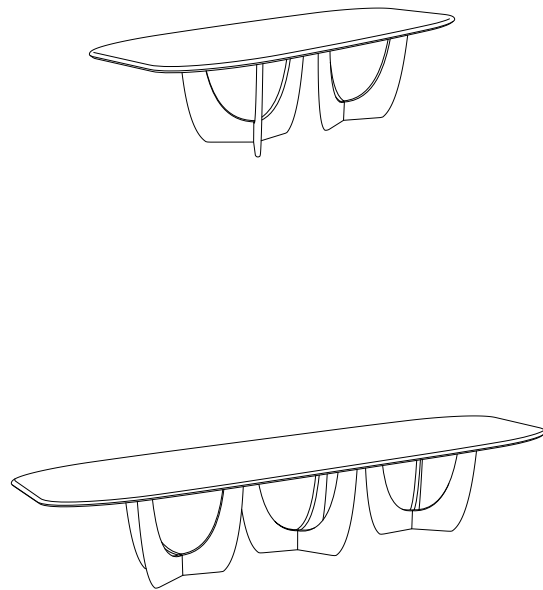
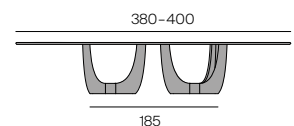
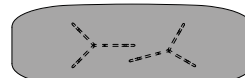
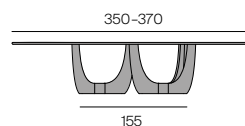
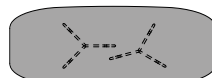
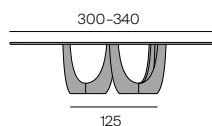
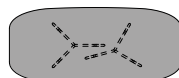
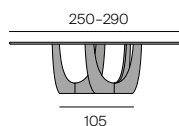
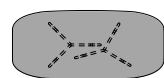
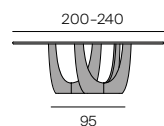

Plattenquerschnitt  
 Cross-section tabletop

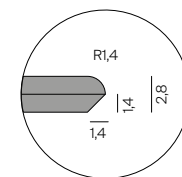

Stand 05/ 2024

**Kabelklappe / -fach**  
Cable flap / compartment

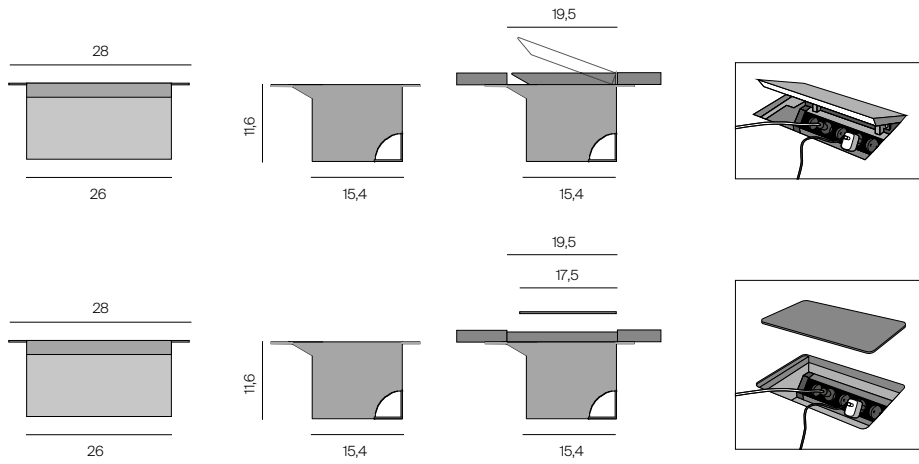

**Kabeldurchführung**  
Grommet

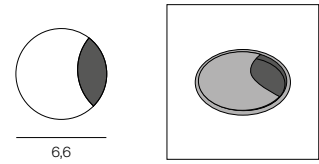

Bestückung separat erhältlich unter: <http://www.evoline.com>  
Matching equipment available separately via: <http://www.evoline.com>

**CALA rund**  
CALA round

